













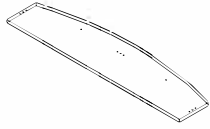





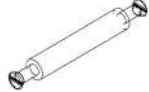

(1) Desk Top  1PCS	(2) Desk End  1PCS	(3) Desk End  1PCS	(4) Desk Modesty  1PCS	(5) Transaction Counter (Desk)  1PCS	(6) Return Top  1PCS	(7) Return End  1PCS	(8) Return Modesty  1PCS
---	--	--	---	--	---	---	---

(A) Dowel  31PCS+2	(B) Cam Pin  23PCS+2	(B/1) Cam Pin  1PCS+1	(C) Cam Lock  28PCS+3	(D) Leg Leveller  8PCS	(W) Grommet  3PCS	(p) Cam Cover  28PCS+4	(N) Cam Cover  6PCS+2	(q) Plug  3PCS+1	(E4) Wood Screw  72PCS+4	(S) Corner Bracket  6PCS
---	---	--	--	---	--	---	--	---	---	---

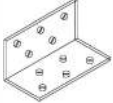
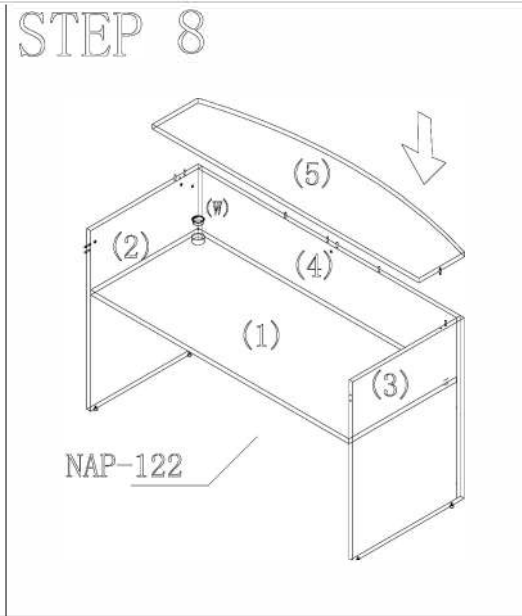
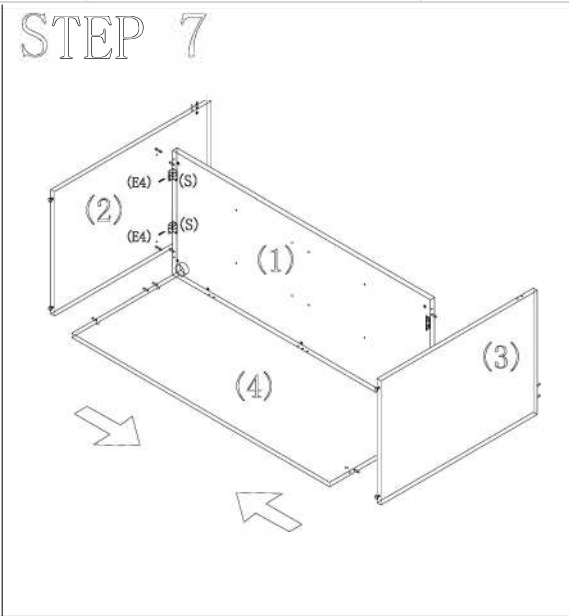
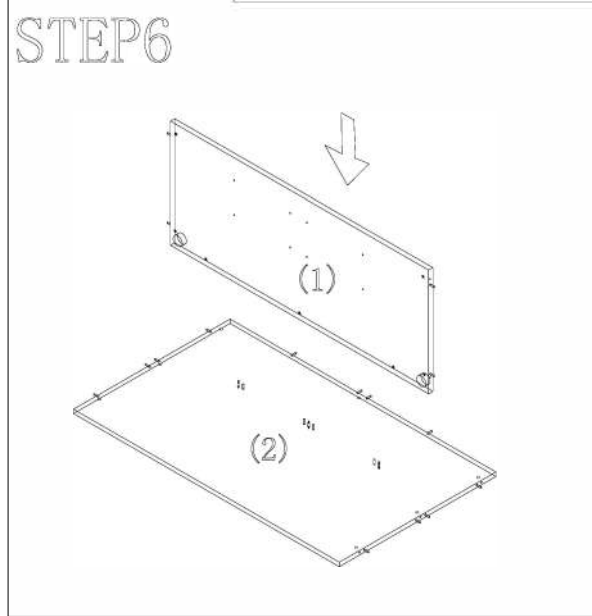
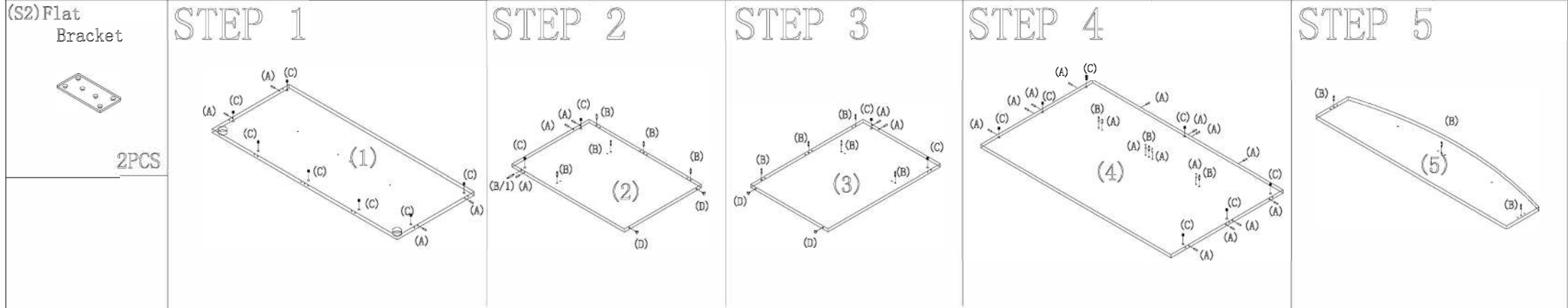

Reception Station
NAP-122
72"W X 72"D X 41"H



Always lay components on A clean, soft-cushioned surface during assembly.